

X2M85A-M3SY

10GBASE -SR , 300 m Reach

Features

- ◆ Compatible with X2 MSA Rev2.0b
- ◆ Support of IEEE 802.3ae 10GBASE-SR at 10.3125Gbps
- ◆ Transmission Distance up to 300m (MMF)
- ◆ Vertical Cavity Surface Emitting Laser at 850nm
- ◆ SC Duplex Optical Connector
- ◆ Hot Pluggable 70-PIN Connector with XAUI Electrical Interface
- ◆ Management and control via MDIO 2-wire interface
- ◆ Power Supply :+3.3V, APS(+1.2V)
- ◆ Diagnostic Optics Monitoring
- ◆ Temperature Range: 0~ 70 °C
- ◆ ROHS Compatible



Applications

- ◆ 10GE Ethernet switches and routers
- ◆ 10GE Core-routers
- ◆ 10GE Storage
- ◆ Other 10Gbps Ethernet Transmission System

Product Description

The X2M85A-M3SY is a highly integrated, Serial optical transponder module for high-speed,

10Gbit/s data transmission applications. 4×3.125Gbps Ethernet Signal Input by XAUI Interface. An integrated Coder / Decoder and multiplexer / demultiplexer (SERDES: Serializer / Deserializer). Designing for 300m Transmission with a vertical cavity surface emitting laser (VCSEL). Digital diagnostics functions are available via a 2-wire serial interface, as specified in the XENPAK MSA 3.0.

Absolute Maximum Ratings

Parameter	Symbol	Min	Max	Unit	Ref.
Storage Ambient Temperature Range		-40	+85	°C	non condensing
Powered case Temperature Range		0	+70	°C	non condensing
Adaptable Power Supply (APS)	Vapsense	0	1.5	V	Voltage @ Pin APS Sense
Supply Voltage Range @ 3.3V	Vcc3	-0.5	4.0	V	

Any stress beyond the maximum ratings can result in permanent damage. The device specifications are guaranteed only under the recommended operating conditions.

Recommended Operating Conditions

Parameter	Symbol	Min	Typical	Max	Unit
Operating Case Temperature	Tc	0		+70	°C
Power Supply Voltage	V _{CC3}	3.14	3.0	3.47	V
	V _{APS}	1.152	1.2	1.248	
Power Dissipation	PD		1.7	2.4	W

XAUI I/O Characteristics

Parameter	Symbol	Min.	Typ.	Max.	Unit	Note
XAUI Data Rate	DR		3.125		Gb/s	
XAUI Baud Rate Tolerance		-100		+100	ppm	Relative Tolerance
Differential Input Voltage Swing		220		1600	mv	8B/10B Coded Input Signal
Differential Output Voltage Swing		800		1600	mVp-p	RLOAD = 100Ω ± 5%
Differential Input Impedance		80	100	120	Ω	
Total Output Jitter	TJXAUI			0.35	UI	no pre-equalization
Total Deterministic Output Jitter	DJXAUI			0.17	UI	no pre-equalization

Optical Interface

Transmitter Characteristics

Parameter	Symbol	Min.	Typ.	Max.	Unit	Note
Operating Range				300	m	
Operating Date Rate			10.3125		Gb/s	
Average Optics Power	Po	-3		-1	dBm	
Input Centre Wavelength	λ	840	850	860	nm	
Spectral Width	$\Delta \lambda$		0.4	0.45	dB	
Extinction Ratio	ER	5	6.5			
Optical Modulation Amplitude	OMA	525			μ W	
Transmitter and Dispersion Penalty	TDP			3.9	dB	

Receiver Characteristics







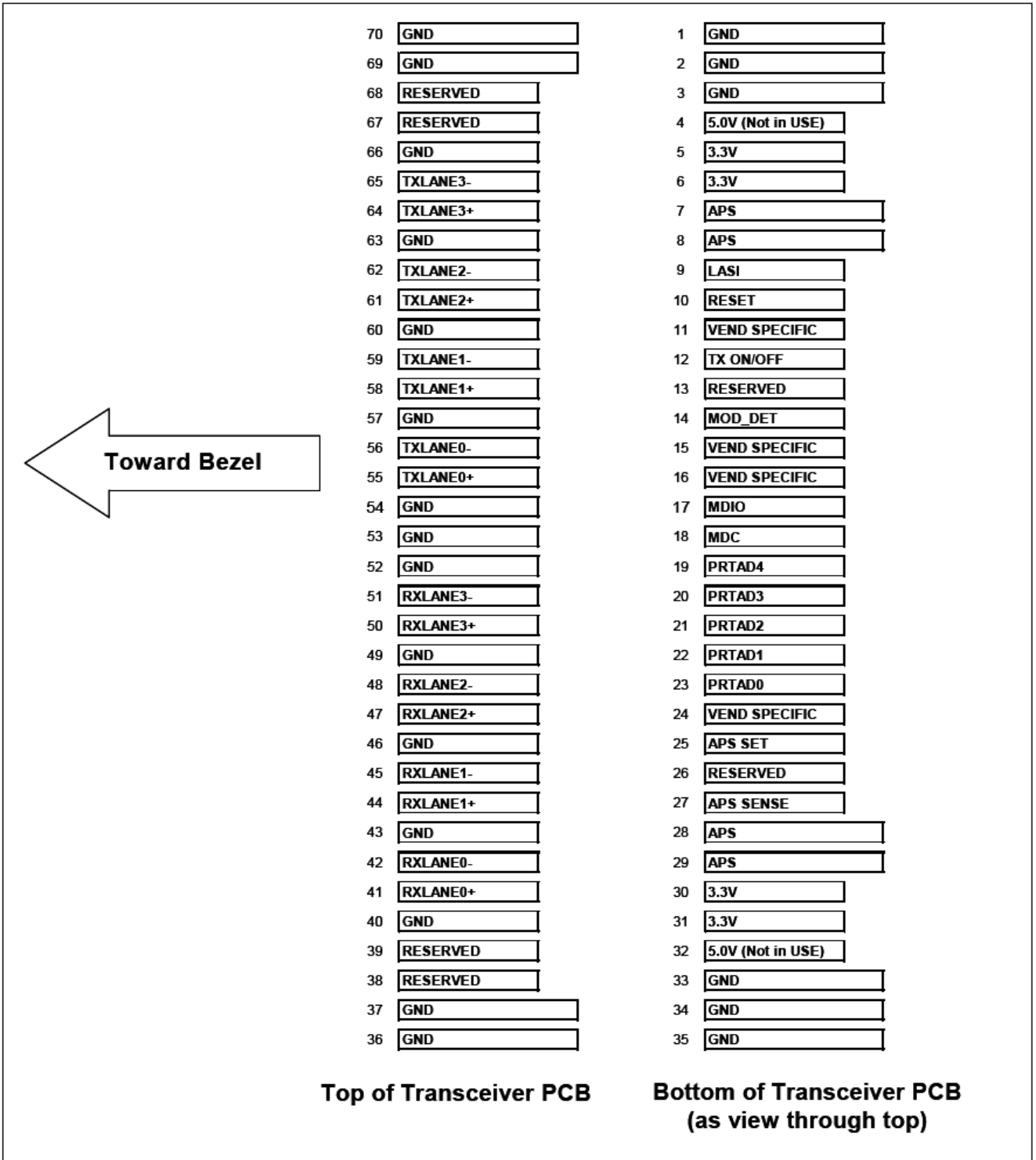































































Parameter	Symbol	Min.	Typ.	Max.	Unit	Note
Operating Date Rate			10.3125		Gb/s	
Average Optics Power	Po	1			dBm	
Minimum Sensitivity	Pmin			-11.1	dBm	1
Stressed Sensitivity in OMA				-7.5	dBm	1

Note :1. Measured at 10.3125Gb/s,Non-framed PRBS2^31-1,NRZ

Electrical PAD Layout



Host PCB X2 PINOUT

1	 GND	GND 	70
2	 GND	GND 	69
3	 GND	RESERVED 	68
4	 5.0V (Not in USE)	RESERVED 	67
5	 3.3V	GND 	66
6	 3.3V	TXLANE3- 	65
7	 APS	TXLANE3+ 	64
8	 APS	GND 	63
9	 LASI	TXLANE2- 	62
10	 RESET	TXLANE2+ 	61
11	 VEND SPECIFIC	GND 	60
12	 TX ON/OFF	TXLANE1- 	59
13	 RESERVED	TXLANE1+ 	58
14	 MOD_DET	GND 	57
15	 VEND SPECIFIC	TXLANE0- 	56
16	 VEND SPECIFIC	TXLANE0+ 	55
17	 MDIO	GND 	54
18	 MDC	GND 	53
19	 PRTAD4	GND 	52
20	 PRTAD3	RXLANE3- 	51
21	 PRTAD2	RXLANE3+ 	50
22	 PRTAD1	GND 	49
23	 PRTAD0	RXLANE2- 	48
24	 VEND SPECIFIC	RXLANE2+ 	47
25	 APS SET	GND 	46
26	 RESERVED	RXLANE1- 	45
27	 APS SENSE	RXLANE1+ 	44
28	 APS	GND 	43
29	 APS	RXLANE0- 	42
30	 3.3V	RXLANE0+ 	41
31	 3.3V	GND 	40
32	 5.0V (Not in USE)	RESERVED 	39
33	 GND	RESERVED 	38
34	 GND	GND 	37
35	 GND	GND 	36

Pin Descriptions

PIN NO	Name	Dir	Logic	Function	Notes
1	GND			Electrical Ground	
2	GND			Electrical Ground	
3	GND			Electrical Ground	
4	5.0V			Power	
5	3.3V			Power	
6	3.3V			Power	
7	APS			Adaptive Power Supply	
8	APS			Adaptive Power Supply	
9	LASI	O	1.2V CMOS Open Drain	Link Alarm Status Interrupt, low active, Open Drain Output A pull-up resistor with 10-22KΩ to 1,2V is expected. Logic High: Normal Operation Logic Low: Link Alarm is indicated	
10	Reset	I	1.2V CMOS Open Drain	Low active Reset Input 10KΩ pull-up on Transceiver Logic high = Normal Operation Logic Low = Reset asserted	
11	VEND SPECIFIC			Vendor Specific Pin,. leave unconnected	
12	TX ON/OFF	I	1.2V CMOS Open Drain	High active Transmitter Enable Input 10KΩ pull-up on Transceiver Logic high = Transmitter active (normal Operation) And Register Bit 1.9.0 set to low as well Logic Low = shut down of Transmitter	
13	RESERVED			RESERVED	
14	MOD DETECT	O		1kΩ to Ground On Transceiver	
15	VEND SPECIFIC			Vendor Specific Pin,. leave unconnected	
16	VEND SPECIFIC			Vendor Specific Pin,. leave unconnected	
17	MDIO	I/O	1.2V CMOS	Management Data I/O. Requires external 10-22 kΩ pull-up to 1.2 V on host.	
18	MDC	I	1.2V CMOS	Management Clock Input	
19	PRTAD4	I		Port Address Bit 4(LOW=0)	
20	PRTAD3	I		Port Address Bit 3(LOW=0)	
21	PRTAD2	I		Port Address Bit 2(LOW=0)	
22	PRTAD1	I		Port Address Bit 1(LOW=0)	
23	PRTAD0	I		Port Address Bit 0(LOW=0)	
24	VEND SPECIFIC			Vendor Specific Pin,. leave unconnected	
25	APS SET	I		Feedback Input for APS, Input of APS Setting Resistor	
26	RESERVED			RESERVED	

27	APS SENSE	O		APS Sense Output for APS Control Circuit	
28	APS			Adaptive Power Supply	
29	APS			Adaptive Power Supply	
30	3.3V			Power	
31	3.3V			Power	
32	5.0V			Power	
33	GND			Electrical Ground	
34	GND			Electrical Ground	
35	GND			Electrical Ground	

PIN NO	Name	Dir	Logic	Function	Notes
36	GND			Electrical Ground	
37	GND			Electrical Ground	
38	RESERVED			RESERVED	
39	RESERVED			RESERVED	
40	GND			Electrical Ground	
41	RX LANE 0+			Module XAUI Output Lane 0+	
42	RX LANE 0-			Module XAUI Output Lane 0-	
43	GND			Electrical Ground	
44	RX LANE 1+			Module XAUI Output Lane 1+	
45	RX LANE 1-			Module XAUI Output Lane 1-	
46	GND			Electrical Ground	
47	RX LANE 2+			Module XAUI Output Lane 2+	
48	RX LANE 2-			Module XAUI Output Lane 2-	
49	GND			Electrical Ground	
50	RX LANE 3+			Module XAUI Output Lane 2+	
51	RX LANE 3-			Module XAUI Output Lane 2-	
52	GND			Electrical Ground	
53	GND			Electrical Ground	
54	GND			Electrical Ground	
55	RX LANE 0+			Module XAUI Output Lane 0+	

56	RX LANE 0-			Module XAUI Output Lane 0-	
57	GND			Electrical Ground	
58	TX LANE 1+			Module XAUI Output Lane 1+	
59	TX LANE 1-			Module XAUI Output Lane 1-	
60	GND			Electrical Ground	
61	TX LANE 2+			Module XAUI Output Lane 2+	
62	TX LANE 2-			Module XAUI Output Lane 2-	
63	GND			Electrical Ground	
64	TX LANE 3+			Module XAUI Output Lane 2+	
65	TX LANE 3-			Module XAUI Output Lane 2-	
66	GND			Electrical Ground	
67	RESERVED			RESERVED	
68	RESERVED			RESERVED	
69	GND			Electrical Ground	
70	GND			Electrical Ground	

Block Diagram of Adapter Power Supply Circuit

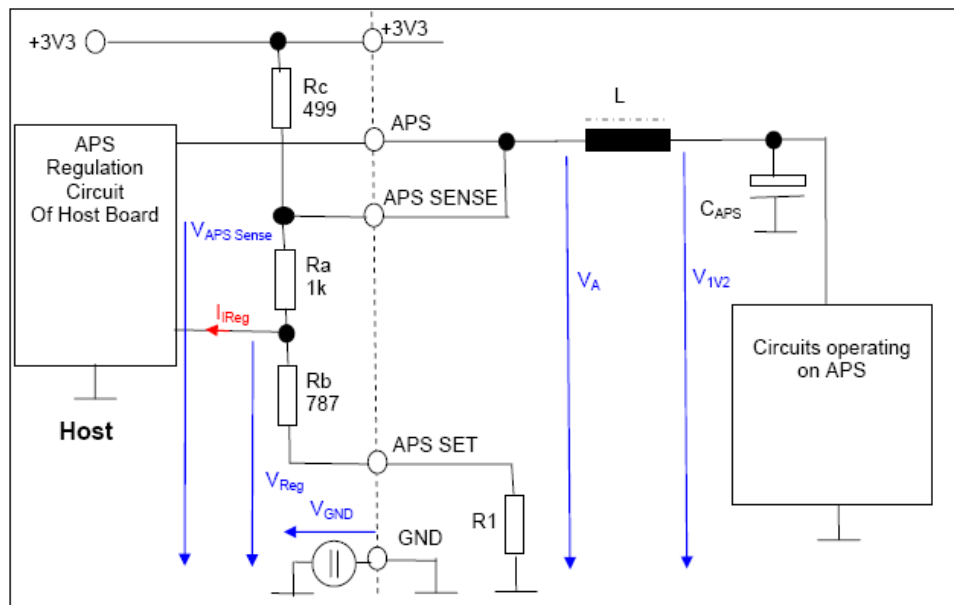

Package Dimensions

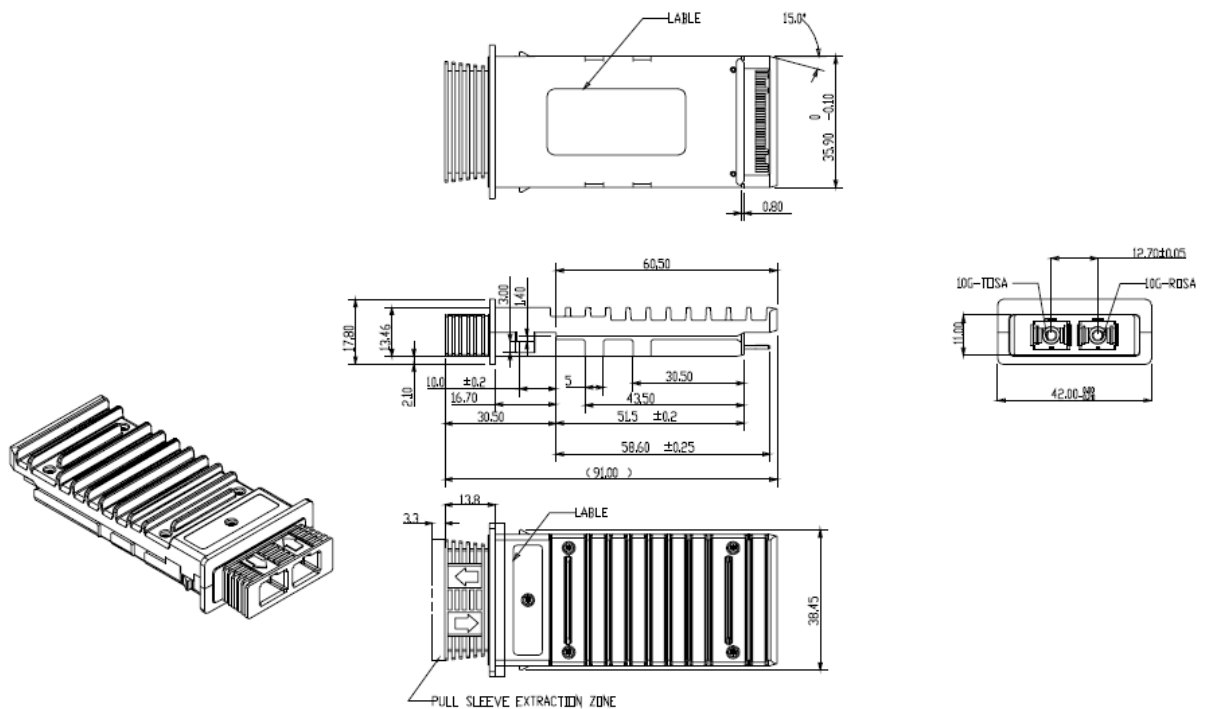

Ordering information

Part Number	Product Description
X2M85A-10SY	850nm, 10.3125Gbps, 300m, 0°C ~ +70°C

E-mail: info@xenya.si

Web: <http://www.xenya.si>